

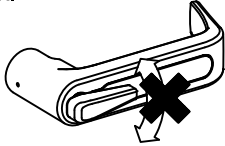

# Classroom Security Indicator Lever Installation and Operation Instructions

## Installation

1) Install lock chassis using instruction sheet provided with the lock.



**CAUTION** : Do not rotate thumb turn prior to installation.

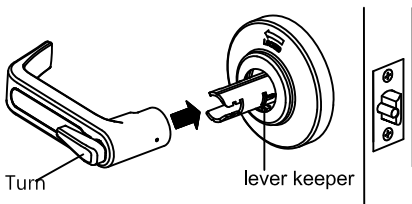

2) Insert the lever onto the inside spindle.

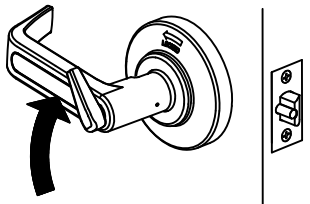

3) Rotate the thumb turn approximately 45 degrees clockwise, and push the lever firmly until the lever clicks securely onto the chassis.

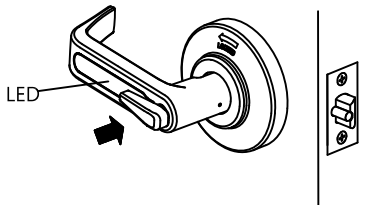

4) Rotate the thumb turn back to horizontal position.

## Operation

1) After installing the inside lever handle, test lock for proper operation.

(Picture 1)

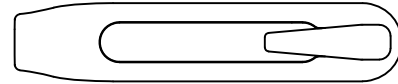

2) Thumb turn should be in "home" (horizontal) position after installation (Picture 1).

(Picture 2)

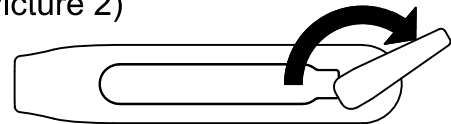

3) Fully rotate the thumb turn clockwise to unlock the outside lever handle (Picture 2).

(Picture 3)

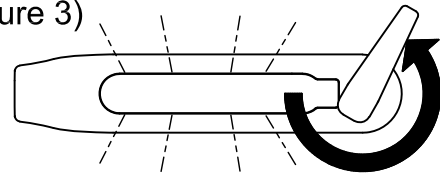

4) Fully rotate the thumb turn counter clockwise to lock the outside lever handle and activate the lighted indicator (Picture 3).

**NOTE:** The indicator light will flash for 45 minutes and then shut off automatically, although the lock remains locked.

## Battery Replacement

1) Remove the battery cover located on the bottom side of the lever handle

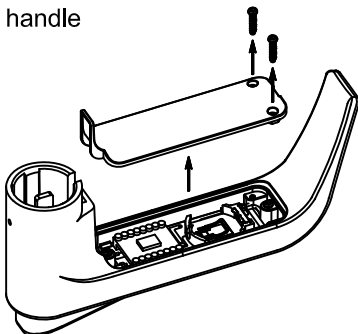

2) Insert (1) CR2032 battery with the + side facing up.

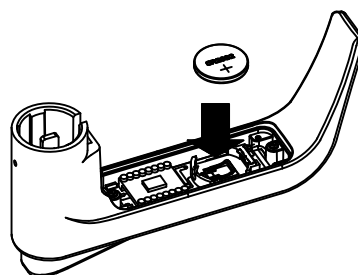

3) Replace the battery cover.

