



GRADE 1 & GRADE 2 KNOB CYLINDRICAL LOCKSETS

Features

- Multiple latch backset choices available.
- Double keyed functions available.
- Completely reversible handing.
- Multiple finishes available.
- Uniquely tailored masterkey systems backed by extensive industry experienced system design and support.
- 5 Year Warranty.



Specifications:













- Door Thickness** 1 3/8" to 2" wood or metal door
- Backsets** 2 3/4" (standard), 2 3/8", 3 3/4", 5" available
- Latchbolts** 1/2" throw, UL listed, self-adjusting faceplate, 3/4" throw available (1CK only)
- Strikes** ANSI, T-Strike and full lip strikes are available
- Trim** Heavy wrought brass roses, wrought steel inside and outside reinforcing rose liners with concealed screws
- IC Core** Interchangeable 6 & 7 pin compatible with all other small format interchangeable core housings
- Non-IC Cylinder** Standard "C" keyway, compatible with Schlage (Optional)
- Masterkeying** Tailored masterkey system set-up and design. Construction cores available.
- Finishes** 605(Bright Brass), 606(Satin Brass), 612(Satin Bronze), 613(Dark Bronze), 625(Bright Chrome) and 626(Satin Chrome)
- Certification** 1CK: UL listed "A" label (3 hour) single swing door. ANSI A156.2, Series 4000 Grade 1
2CK: UL listed "A" label (3 hour) single swing door. ANSI A156.2, Series 4000 Grade 2

OAK HOW TO ORDER GUIDE - Grade 1 & Grade 2 Knob Cylindrical Locksets

1CK	3	EN	1	R	1	A	626	LC
-----	---	----	---	---	---	---	-----	----

Series	Backset	Function	Core	Knob Style	Rose	Strike	Finish	Keying
1CK = Grade 1 Cylindrical Knob	2 = 2-3/8" 3 = 2-3/4" 4 = 3-3/4" 5 = 5"	CL = Classroom EN = Entrance ST = Storeroom CR = Connecting Room (see function chart for additional)	0 = None 1 = Oak Format IC 2 = Standard "C" Non-I/C plug	R = Round	1 = Default	A = ANSI T = T FLS = Full Lip Square FL4 = Full Lip 1/4"	605 606 612 613 625 626	LC = Less Core KE = Keyed
2CK = Grade 2 Cylindrical								

CYLINDRICAL LOCK FUNCTIONS

Function	Description	Operation Description
SINGLE KEYED		
	EN (F109) Entry/Office	Turn button locking: Pushing and turning the inside button clockwise locks the outside knob. Inside knob is always unlocked. Turning key in outside knob will retract latch. Push button locking: Pushing the inside button will lock outside knob. Inside knob is always unlocked. When button is pushed, turning inside knob or key in outside knob will release the button and latch.
	CL (F84) Classroom	Outside knob is locked or unlocked by rotating the key 360°. Inside knob is always unlocked.
	CR Connecting Room	Knob is locked or unlocked by rotating key 360°. Outside is a blank plate.
	ST (F86) Store Room	Outside knob is always locked. Turning key retracts latch. Inside knob is always unlocked.
DOUBLE KEYED		
	CO (F80) Communicating Lock	Turning key in either knob locks or unlocks its own knob independent of the other knob.
	IN (F87) Institutional Lock	Both knobs always locked. Key in either knob retracts latch, but does not unlock knob.
	SD (F91) Store Door	Turning key in either side of door locks or unlocks both sides.
	VE (F88) Vestibule	Outside knob is locked or unlocked by key in inside knob. When outside knob is locked, key in outside knob will retract the latch. Inside knob is always unlocked.
NON-KEYED		
	CE Connecting/Exit	Inside knob is always unlocked. Outside has a blank plate.
	DT Single Dummy Trim	Dummy trim used on one side of door.
	PA (F75) Passage	Both sides always unlocked.
	PR (F76) Privacy	Both sides unlocked unless button on inside knob pushed. Closing door or turning emergency release in outside knob, or turning inside knob, releases button and unlocks outside knob.

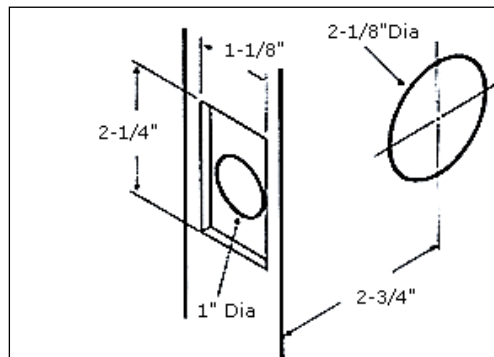

Oak Security Group, LLC
8904 Bash Street, Suite K
Indianapolis, Indiana 46256

Toll-free: 877-OSG-LOCK
Phone: 317-585-9830
Fax: 317-585-9834

www.OakSecurity.com